

cMOR Single and Dual DC-DC Converters

15 TO 50 VOLT INPUT - UP TO 120 WATT

FEATURES

- Parallel operation with current share, up to 5 units (540 watts)
- Output flexibility, trim of 80% to 110%
- Operating temperature -55 °C to +105 °C
- Input voltage 15 to 50 V
- Fully isolated, magnetic feedback
- Fixed high frequency switching
- Remote sense on single output models
- Inhibit function
- Sync In and Sync Out
- Indefinite short circuit protection
- High power density with up to 90% peak efficiency
- Soft-start function limits inrush current during start-up



MODELS	
OUTPUT VOLTAGE (V)	
SINGLE	DUAL
3.3	±5
5	±6.3
6.3	±9.5
9.5	±12
12	±15
15	
28	

DESCRIPTION

The Interpoint® cMOR Series™ of DC-DC converters offers up to 120 watts of power in a low profile package with a 15 to 50 volt input. The cMOR converters are manufactured in our fully certified and qualified MIL-PRF-38534 Class H or class K production facility and packaged in hermetically sealed steel cases. cMOR converters are ideal for use in programs requiring high reliability, small size, and high efficiency. Full operation over the temperature range, -55 °C to +105 °C, makes the cMOR Series an ideal choice for military, aerospace, space, and other high reliability applications. Use Interpoint FMCE-1528 EMI filter to meet the requirements of MIL-STD-461C CE03 and MIL-STD-461D-G CE102 levels of conducted emissions.

The converters are offered standard screening or “ES” screening.

The cMOR Series converters uses an active-clamp reset, single-ended forward converter with synchronous rectification design. It uses a constant frequency Pulse Width Modulator (PWM) current mode control design with a constant switching frequency of 500 kHz.

SPAN VOLTAGE

The dual models can be used as a single output voltage by connecting the load between positive and negative outputs, leaving the common unconnected resulting in double the output voltage. For example, cMOR2815D can be used as a 30 volt output. When using a dual to double the output voltage (span voltage) the maximum load capacitance across the span voltage is half that specified for each output.

SHORT CIRCUIT PROTECTION

The converters also provide short circuit protection by restricting the current to 125% of the full load output current, typical.

INHIBIT FUNCTION

All models offer two inhibits, one referenced to input common and one referenced sense return (single output models) or to output common (dual output models). A remote sense function is available on single output models.

TRIM FUNCTION

Using the trim function, the cMOR Series can adjust any output between 80% -110% of the nominal voltage for both single and dual output models.

cMOR Single and Dual DC-DC Converters

15 TO 50 VOLT INPUT - UP TO 120 WATT

HOW TO USE THE FUNCTIONS

INPUT VOLTAGE

Steady state voltage range is 15 to 50 V. All models include a soft-start function to prevent large current draw and minimize overshoot.

EMI INPUT FILTERS

Internal 500 volt capacitors (dielectric working voltage (DWV) 700 volts) are connected between the case and input common and between the case and output common.

Use Interpoint FMCE-1528 or equivalent EMI filter to meet the requirements of MIL-STD-461C CE03 and MIL-STD-461D thru G CE102. When using an external input filter it is important that the case of the filter and the case of the converter be connected through as low an impedance as possible. Direct connection of the baseplates to chassis ground is the best connection. If connected by a single trace, the trace should be as wide as it is long. See Figure 1.

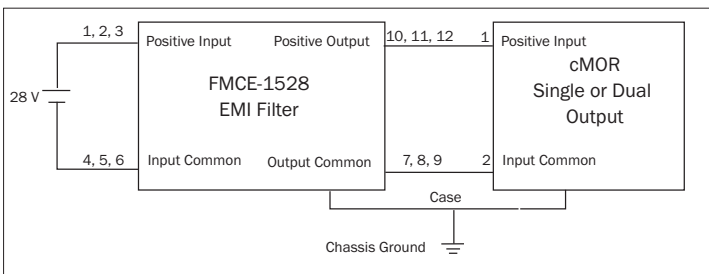

FIGURE 1: EXTERNAL FILTER CONNECTION

TRIM

Both single and dual output models include a trim function. Output voltage can be trimmed from 80% up to 110% of nominal V_{out} . When trimming up, do not exceed the maximum output power. When trimming down, do not exceed the maximum output current. At 110% trim high, low line drop out may occur below minimum input voltage. See Figure 2.

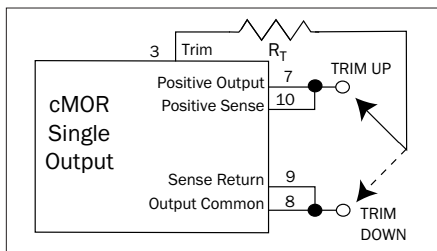

FIGURE 2: TRIM - SINGLE

On dual models the positive output is regulated and the negative output is transformer coupled (cross-regulated) to the positive output. When trimming the duals, both output voltages will be adjusted equally. See Figure 3.

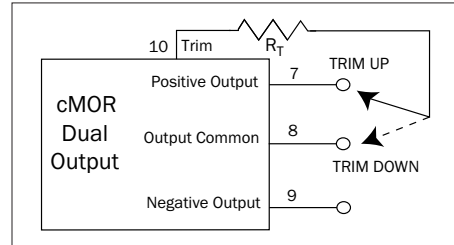

FIGURE 3: TRIM - DUAL

V normal (V)	X	Rint
3.3	0.757	30.1
5	0.5	40.2
6.3	0.396	40.2
9.5	0.262	40.2
12	0.208	40.2
14 (28 VS)	0.179	40.2
15	0.167	40.2

$$X = \frac{2.5}{V_{out\ normal}}$$

Trim Up:

$$R_T (k\Omega) = \frac{(1-X) * 12}{X - \frac{2.5}{V_o\ Trimmed}} - R_{int}$$

Example $V_{out\ nominal} = 5V, V_{out\ trimmed} = 5.5V$
 $X = 0.5, R_T = 91.8 (k\Omega)$

Trim Down:

$$R_T (k\Omega) = \frac{X * V_o\ trimmed * 12}{2.5 - X * V_o\ trimmed} - R_{int}$$

Example $V_{out\ nominal} = 5V, V_{out\ trimmed} = 4.5V$
 $X = 0.5, R_T = 67.8 (k\Omega)$

cMOR Single and Dual DC-DC Converters

15 TO 50 VOLT INPUT - UP TO 120 WATT

INHIBIT 1 AND 2

Two inhibit terminals disable switching, resulting in no output and very low quiescent input current. The two inhibit pins allow access to an inhibit function on either side of the isolation barrier to help maintain isolation.

An open collector is required for interfacing with both of the inhibit pins. Pulling either inhibit pin low will inhibit the converter. Leaving the pins open will enable the converter. Inhibit 1 is referenced to Input Common. Inhibit 2 is referenced to Sense Return for single output models and to Output Common for dual output models.

The open circuit voltage (unit enabled) for Inhibit 1 is 19 V and for Inhibit 2 it is up to 4.9 V. Leave the Inhibit pins unconnected if not used. The required active low voltage level is 0.8 V maximum for Inhibit 1 and 0.2 V maximum for Inhibit 2.

UNDERVOLTAGE LOCKOUT

Undervoltage lockout prevents the units from operating below approximately 14.5 volts input voltage to keep system current levels smooth, especially during initialization or re-start operations.

SYNC IN AND SYNC OUT

The cMOR converters can be synchronized to the system clock by applying an active high sync signal to the Sync In pin. Sync Out can be used to synchronize other components to the cMOR converter's switching frequency.

The frequency range for external synchronization is 450 to 550 kHz. The requirements for an external signal are 20% to 50% duty cycle, $0 \leq L \leq 0.8 \text{ V}$ and $3.5 \leq H \leq 7 \text{ V}$. Both Sync In and Sync Out are referenced to input common. Sync In should be left unconnected if not used.

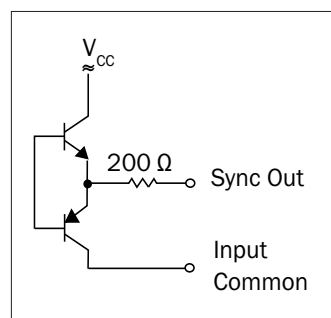

FIGURE 4: SYNC OUT

POSITIVE OUTPUT, NEGATIVE OUTPUT AND OUTPUT COMMON

Output current is typically limited to 125% of maximum specified current under short circuit or load fault conditions.

Single output models operate from no load to full load.

cMOR Single and Dual DC-DC Converters

15 TO 50 VOLT INPUT - UP TO 120 WATT

PARALLELING (SHARE PIN)

By using the Share pin, up to five single or dual converters may be paralleled for a total output power of up to 540 watts, depending on model. To calculate available power, multiply the number of converters (up to five) by their maximum output power. Multiply the result by 90% for total available power. See Figure 5 for the internal circuit. The converters will share within 10% of each other at 25% to 90% for total available power.

Due to the synchronous rectification used in the cMOR, a series diode must be connected between the Positive Output pin and the load. The Positive Sense must be connected to the Positive Output on the anode side of the series diode. Voltage trim may be used to compensate for the voltage drop across the external diode. If the Positive Sense must be connected to the load, please see xMOR Current Sharing white paper or contact Application Engineering @ powerapps@craneae.com for additional instructions.

All Negative Outputs and Sense Returns should be connected to a common point. The Share pin is referenced to Sense Return. Leave the share pin floating (unconnected) if not used. Also see Figure 5.

CAPACITIVE LOAD

Care must be taken when applying a capacitive load on the cMOR as a load transient into no load may lead to negative current flow into the converter and cause damage to the device.

In current share configurations, a capacitive load shall not be placed on the anode side of the series diode, but may be placed on the cathode side.

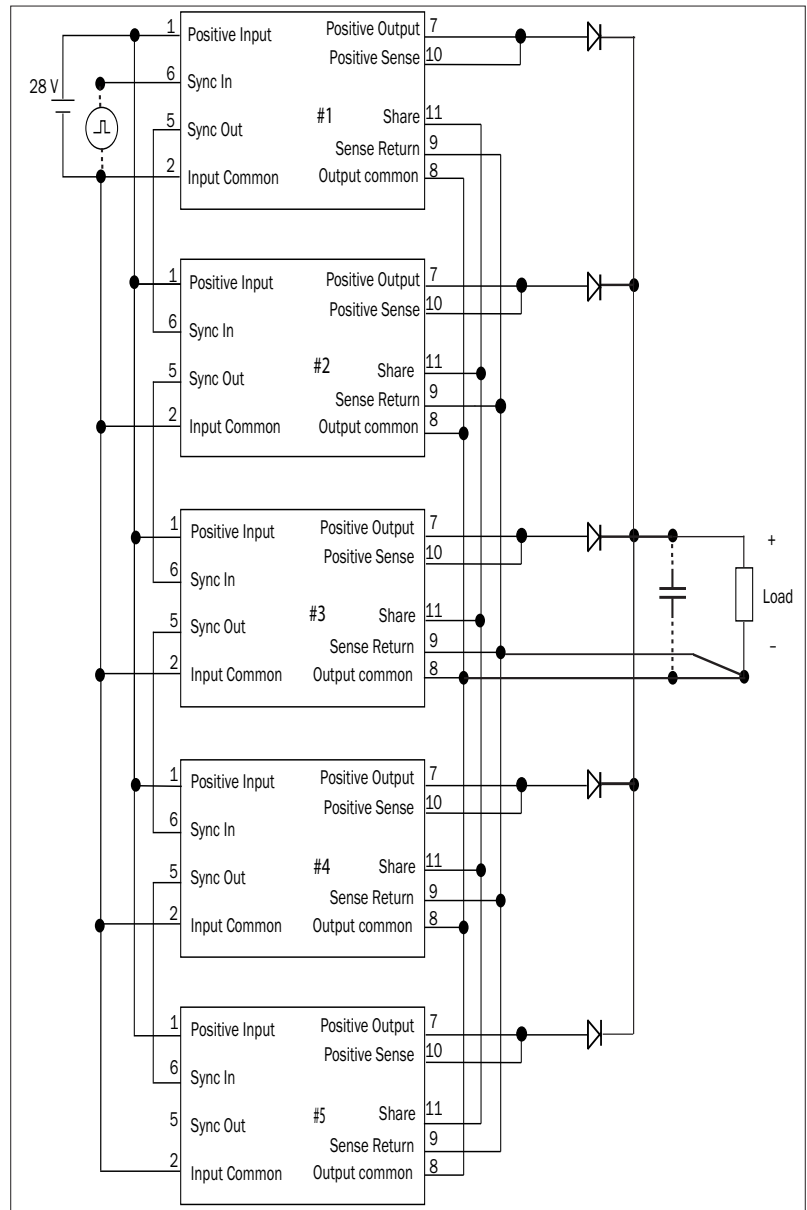

FIGURE 5: PARALLELING

cMOR Single and Dual DC-DC Converters

15 TO 50 VOLT INPUT - UP TO 120 WATT

POSITIVE SENSE AND SENSE RETURN

A special remote sensing feature maintains the desired output voltage at the load. When this feature is not used, connect the sense lines to their respective output terminals. See Figure 6. Remote sensing is available on single output models only. Do not exceed 110% of V_{out} and do not exceed maximum output power.

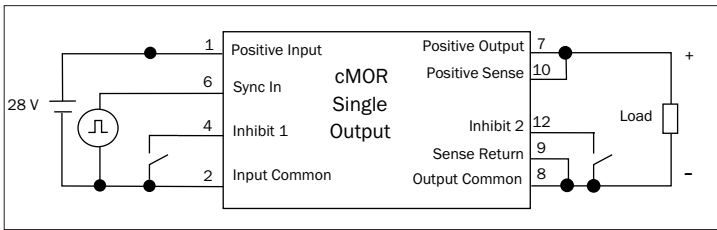

FIGURE 6: TYPICAL CONNECTIONS WITH SENSE PIN

INCREASE OUTPUT VOLTAGE BY SPANNING OUTPUTS

Dual outputs may be spanned to increase the output voltage. cMOR duals can also be configured as a single output where the positive output is used as one rail and the negative output is used as the other rail. As an example the positive and negative 15 volt dual can be configured as a single 30 volt output. This can be used as a positive 30 volt output or a negative 30 volt output. See Figure 7. In all cases Output Common of the converter is not connected. If the dual is configured as a positive 30 volt output the negative output would be used as system ground and the positive output would be used as the positive 30 volt output.

If the dual is configured as a negative 30 volt output the positive output would be used as system ground and the negative output would be used as the negative 30 volt output.

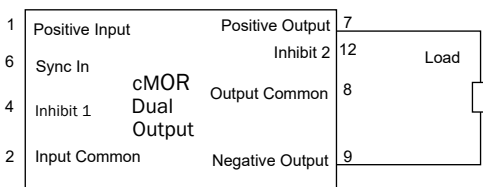

FIGURE 7: SPAN OUTPUT CONNECTION - DUAL MODEL

The maximum capacitance when using a span voltage on a dual is half the value specified for each output. Inhibit 2 cannot be referenced to system ground when spanning voltages. Leave Inhibit 2 floating if not in use. If Inhibit 2 is needed, please contact Applications Engineering at powerapps@craneae.com.

OUTPUT OVERLOAD AND SHORT-CIRCUITS PROTECTION

The cMOR converters are protected against indefinite short circuits when the short circuit output voltage is less than 900 mV. Figure 8 below shows the overload characteristics of the output voltage versus output current. Between the current limit trip point and the short circuit is the output overload, where a continuous operation in this state may damage or substantially shorten the life of these converters. To prevent damage, the converters should not operate in overload for more than 100 ms.

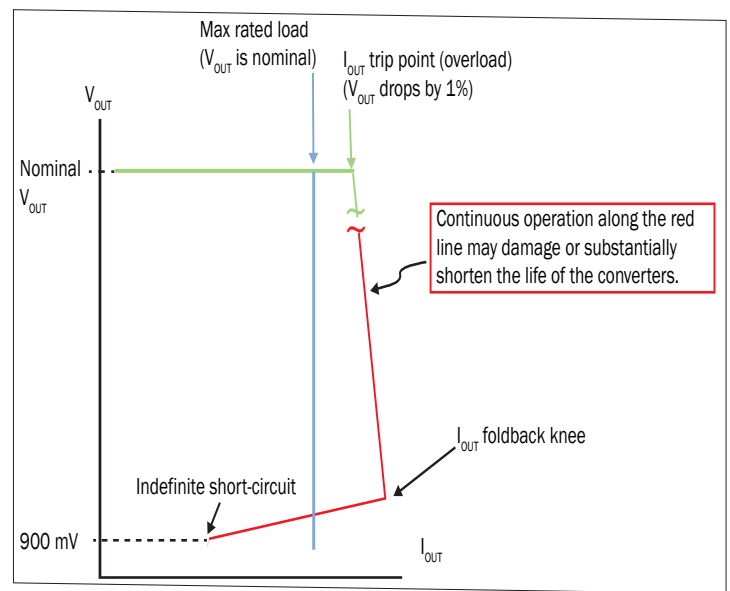

FIGURE 8: OUTPUT OVERLOAD AND SHORT-CIRCUITS PROTECTION

cMOR Single and Dual DC-DC Converters

15 TO 50 VOLT INPUT - UP TO 120 WATT

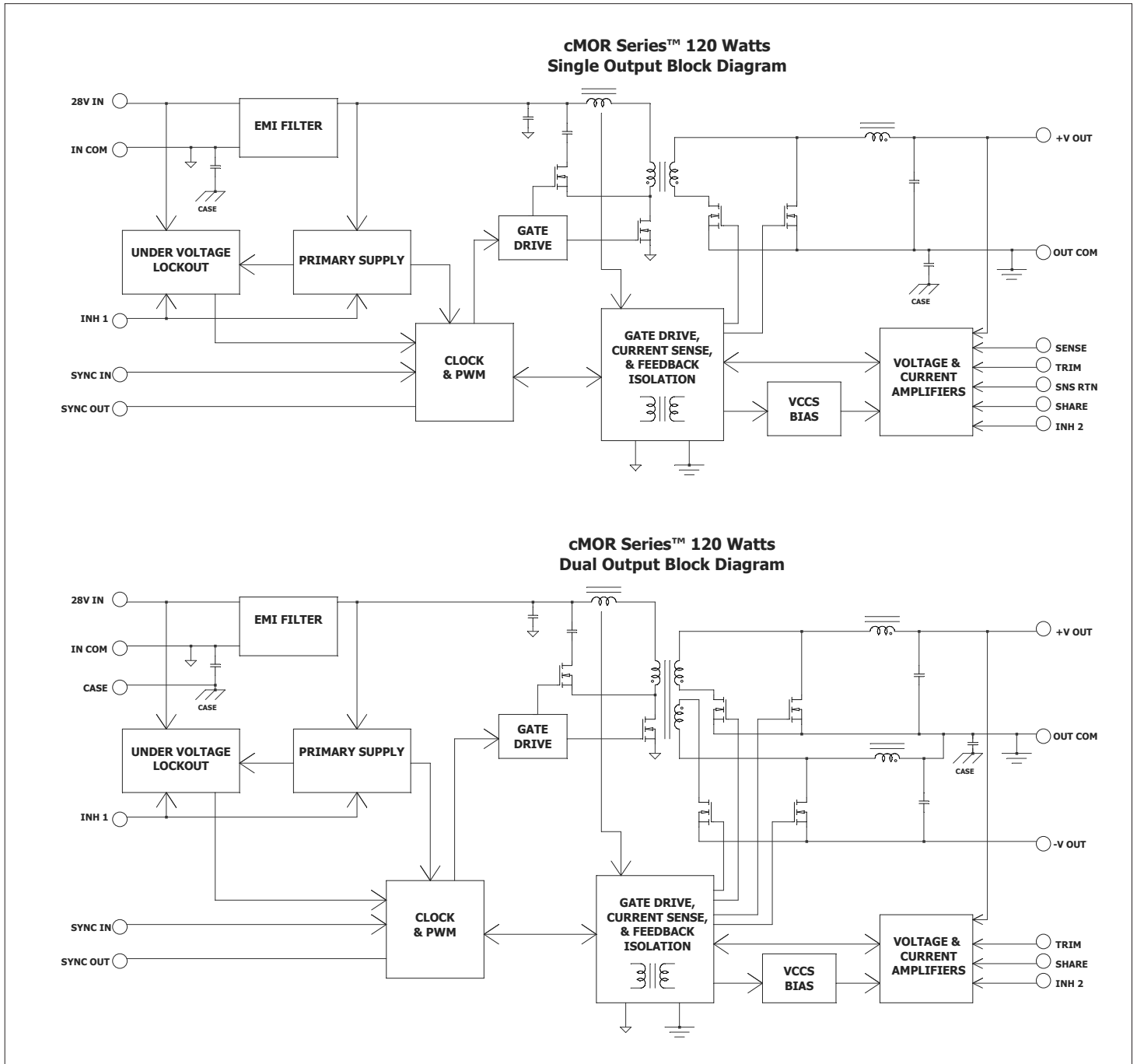

FIGURE 9: cMOR SINGLE AND DUAL OUTPUT BLOCK DIAGRAM

cMOR Single and Dual DC-DC Converters

15 TO 50 VOLT INPUT - UP TO 120 WATT

PIN OUT			
Pin	Single Output	Dual Output	cMOR2828S ONLY
1	Positive Input	Positive Input	Positive Input
2	Input Common	Input Common	Input Common
3	Trim	Case	Case
4	Inhibit 1 (INH1)	Inhibit 1 (INH1)	Inhibit 1 (INH1)
5	Sync Out	Sync Out	Sync Out
6	Sync In	Sync In	Sync In
7	Positive Output	Positive Output	Positive Output
8	Output Common	Output Common	Pin-8 Trim/INH 2 RTN. Use Pin-8 as return for Trim, Share, and/or Inh 2 functions only. Leave unconnected otherwise
9	Sense Return	Negative Output	Output Common
10	Positive Sense	Trim	Trim
11	Share	Share	Share
12	Inhibit 2 (INH2)	Inhibit 2 (INH2)	Inhibit 2 (INH2)

TABLE 1: PIN OUT

PINS NOT IN USE	
Case	User's discretion
Inhibit (INH1, INH2)	Leave unconnected
Sense Lines	Must be connected to the appropriate outputs
Sync In	Leave unconnected
Sync Out	Leave unconnected
Share	Leave unconnected
Trim	Leave unconnected

TABLE 2: PINS NOT IN USE

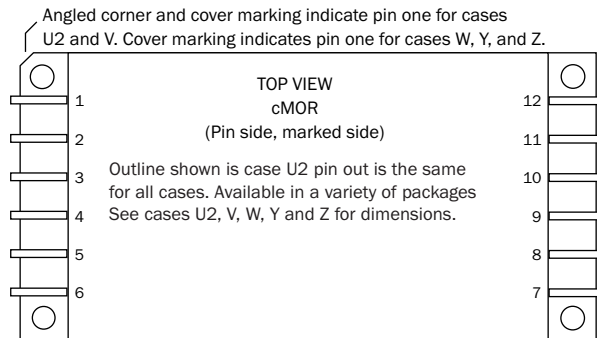

FIGURE 10: PIN OUT TOP VIEW

cMOR Single and Dual DC-DC Converters

15 TO 50 VOLT INPUT - UP TO 120 WATT

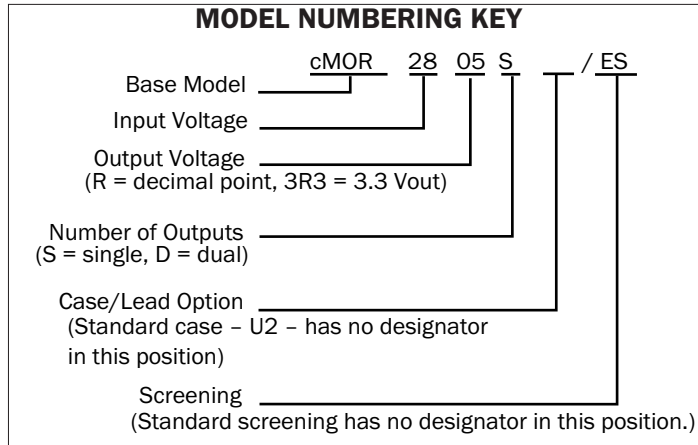

Figure 11: Model Numbering Key

MODEL NUMBER OPTIONS						
TO DETERMINE THE MODEL NUMBER ENTER ONE OPTION FROM EACH CATEGORY IN THE FORM BELOW.						
CATEGORY	Base Model and Input Voltage	Output Voltage ¹	Number of Outputs ²	Case Options ³	Screening	Lead Plating ⁴
OPTIONS	cMOR28	3R3, 05, 6R3, 9R5, 12, 15, 28	S	(U2, leave blank)	(standard screening)	Au (leave blank)
		05, 6R3, 9R5, 12, 15	D	V, W, Y, Z	ES	Solder dip (-Q)
FILL IN FOR MODEL # ⁸	cMOR28	_____	_____	_____	/ _____	_____

Notes

- Number of Outputs: S is a single output. D is for dual output.
- Case Options: For the standard case, U2, leave the case option blank. For other case options, insert the letter that corresponds to the desired case. See Figure 29 through Figure 33 for case designators and dimensions.
- Screening: For standard screening leave the screening option blank. For other screening options, insert the desired screening level. For more information see Table 11 on page 23.
- If ordering by model number add suffix "-Q" to request solder dipped leads (cMOR2805S/ES-Q).

TABLE 3: Model Number Options

cMOR Single and Dual DC-DC Converters

15 TO 50 VOLT INPUT - UP TO 120 WATT

TABLE 4: Operating Conditions, All Models, 25 °C case, 28 Vin, 100% load, unless otherwise specified

PARAMETER	CONDITIONS	ALL MODELS			UNITS
		MIN	TYP	MAX	
LEAD SOLDERING TEMPERATURE ¹	10 SECONDS MAX.	—	—	300	°C
STORAGE TEMPERATURE ¹		-65	—	+105	°C
CASE OPERATING TEMPERATURE	FULL POWER	-55	—	+105	°C
	ABSOLUTE ¹	-55	—	+105	
DERATING OUTPUT POWER/CURRENT ¹	LINEARLY	From 100% at 105 °C to 0% at 115 °C			
ISOLATION: INPUT TO OUTPUT, INPUT TO CASE, OUTPUT TO CASE ²	@ 500 V AT 25 °C	100	—	—	Megohms
UNDER VOLTAGE LOCKOUT		—	14.5	—	V
CURRENT LIMIT/POWER LIMIT ³	% OF FULL LOAD	—	125	—	%
AUDIO REJECTION ¹		—	40	—	dB
SWITCHING FREQUENCY		450	500	550	kHz
SYNCHRONIZATION	INPUT FREQUENCY	450	—	550	kHz
	DUTY CYCLE	20	—	50	%
	ACTIVE LOW	—	—	0.8	V
	ACTIVE HIGH	3.5	—	7	
	SYNC IN REFERENCED TO	INPUT COMMON			
	SYNC OUT REFERENCED TO	INPUT COMMON			
INHIBIT ACTIVE LOW (OUTPUT DISABLED) Do not apply a voltage to the inhibit pin. ⁴	INHIBIT 1 PIN PULLED LOW	—	—	0.8	V
	INHIBIT 1 PIN SOURCE CURRENT ¹	—	—	5	mA
	INHIBIT 1 REFERENCED TO	INPUT COMMON			
	INHIBIT 2 PIN PULLED LOW	—	—	0.2	V
	INHIBIT 2 PIN SOURCE CURRENT ¹	—	—	2	mA
	INHIBIT 2 SINGLES REFERENCED TO	SENSE RETURN			
	INHIBIT 2 DUALS REFERENCED TO	OUTPUT COMMON			
INHIBIT ACTIVE HIGH (OUTPUT ENABLED) Do not apply a voltage to the inhibit pin. ⁴	INHIBIT PIN CONDITION	OPEN COLLECTOR OR UNCONNECTED			
	INHIBIT 1 AND 2	UNCONNECTED			
	OPEN INHIBIT 1 PIN VOLTAGE ¹	—	19	—	V
	OPEN INHIBIT 2 PIN VOLTAGE ¹		2.5	—	

For mean time between failures (MTBF) contact Applications Engineering at powerapps@craneae.com

Notes

- Guaranteed by characterization test and/or analysis. Not a production test.
- Isolation is tested with the all input pins (referenced to input common) tied together, and all output pins (referenced to output common) tied together. They are tested for isolation input to output, input to case and output to case. Discharge the pins after each test.
- Current limit is defined as the point at which the output voltage drops by 1%
Dual outputs: The over-current limit will trigger when the sum of the currents from both outputs reaches 125% (typical value) of the maximum rated "total" current of both outputs.
- An external inhibit interface should be used to pull the inhibits low or leave them floating. The inhibit pins can be left unconnected if not used.

cMOR Single and Dual DC-DC Converters

15 TO 50 VOLT INPUT - UP TO 120 WATT

TABLE 5: ELECTRICAL CHARACTERISTICS -55 °C TO +105 °C CASE, 28 VIN, 100% LOAD, UNLESS OTHERWISE SPECIFIED

SINGLE OUTPUT MODELS		cMOR283R3S			cMOR2805S			cMOR 286R3S			UNITS
PARAMETER	CONDITIONS	MIN	TYP	MAX	MIN	TYP	MAX	MIN	TYP	MAX	
OUTPUT VOLTAGE		3.22	3.30	3.38	4.88	5.00	5.13	6.14	6.30	6.46	V
OUTPUT CURRENT	V _{IN} = 15 TO 50 V			24.2		—	24			19	A
OUTPUT POWER	V _{IN} = 15 TO 50 V			80		—	120			120	W
OUTPUT RIPPLE	25 °C			70	—	—	130			90	mV p-p
10 kHz - 20 MHz	-55 °C TO +105 °C		30	80	—	30	130		75	100	
LINE REGULATION	V _{IN} = 15 TO 50 V			17	—	0	20			32	mV
LOAD REGULATION	NO LOAD TO FULL			33	—	0	30			63	mV
INPUT VOLTAGE	CONTINUOUS	15	28	50	15	28	50	15	28	50	V
					—	—	80				
INPUT CURRENT	NO LOAD		70	150	—	90	150		70	150	mA
	INHIBITED-INH1			10	—	—	10			10	
	INHIBITED-INH2			100	—	—	70			100	
INPUT RIPPLE CURRENT	10 kHz - 20 MHz		50	130	—	50	130			130	mA p-p
EFFICIENCY	25 °C	86	87		89	90	—	90	91		%
	-55 °C TO +105 °C	84			88		—	90			
LOAD FAULT ^{2, 3}	SHORT CIRCUIT			35	—	—	35			35	W
POWER DISSIPATION	RECOVERY ¹			30	—	—	10			30	ms
STEP LOAD RESPONSE ^{3, 4}	TRANSIENT			±350	—	—	±250			±500	mV pk
50% - 100% - 50%	RECOVERY			300	—	—	450			300	µs
STEP LINE RESPONSE ^{1, 3, 5}	TRANSIENT			±430	—	—	±400			±500	mV pk
V _{IN} = 15 - 50 - 15 V	RECOVERY			100	—	—	300			100	µs
START-UP ^{3, 6}	DELAY			30	—	—	30			30	ms
	OVERSHOOT ¹			25	—	0	50			50	mV pk
CAPACITIVE LOAD ^{1, 7}	T _C = 25 °C			3500	—	—	3500			3500	µF

Notes

- Guaranteed by characterization test and/or analysis. Not a production test.
- Short circuit is measured with a 10 milliohm (±10%) resistive load.
- Recovery and start-up times are measured from application of the transient or change in condition to the point at which V_{OUT} is within 1% of final value.

- Step load test is performed at 10 microseconds typical.
- Step line test is performed at 100 microseconds ± 20 microseconds.
- Tested on release from inhibit.
- No effect on dc performance.

cMOR Single and Dual DC-DC Converters

15 TO 50 VOLT INPUT - UP TO 120 WATT

TABLE 6: ELECTRICAL CHARACTERISTICS -55°C TO +105°C CASE, 28 VIN, 100% LOAD, UNLESS OTHERWISE SPECIFIED

SINGLE OUTPUT MODELS		cMOR289R5S			cMOR2812S			cMOR2815S			UNITS
PARAMETER	CONDITIONS	MIN	TYP	MAX	MIN	TYP	MAX	MIN	TYP	MAX	
OUTPUT VOLTAGE		9.31	9.50	9.69	11.76	12.00	12.24	14.70	15.00	15.30	V
OUTPUT CURRENT	V _{IN} = 15 TO 50 V			12.63		–	10			8.0	A
OUTPUT POWER	V _{IN} = 15 TO 50 V			120			120			120	W
OUTPUT RIPPLE	25°C			100	–	–	100			150	mV p-p
10 kHz - 20 MHz	-55°C TO +105°C		30	120	–	30	120		75	75	
LINE REGULATION	V _{IN} = 15 TO 50 V			48	–	0	60			150	mV
LOAD REGULATION	NO LOAD TO FULL			95	–	0	120			50	mV
INPUT VOLTAGE	CONTINUOUS	15	28	50	15	28	50	15	28	50	V
INPUT CURRENT	NO LOAD		70	150	–	90	150		70	150	mA
	INHIBITED-INH1			10	–	–	10			10	
	INHIBITED-INH2			100	–	–	100			100	
INPUT RIPPLE CURRENT	10 kHz - 20 MHz		50	130	–	50	130		50	130	mA p-p
EFFICIENCY	25°C	90	90		90	92	–	90	91		%
	-55°C TO +105°C	90			89		–	90			
LOAD FAULT ^{2, 3}	SHORT CIRCUIT			35	–	–	35			35	W
POWER DISSIPATION	RECOVERY ¹			30	–	–	10			30	ms
STEP LOAD RESPONSE ^{3, 4}	TRANSIENT			TBD	–	–	TBD			TBD	mV pk
	RECOVERY			300	–	–	300			300	µs
STEP LINE RESPONSE ^{1, 3, 5}	TRANSIENT			±570	–	–	±600			±600	mV pk
	RECOVERY			100	–	–	100			100	µs
START-UP ^{3, 6}	DELAY			30	–	–	30			30	ms
	OVERSHOOT ¹			50	–	0	50			50	mV pk
CAPACITIVE LOAD ^{1, 7}	T _C = 25°C			3500	–	–	3500			3500	µF

Notes

- Guaranteed by characterization test and/or analysis. Not a production test.
- Short circuit is measured with a 10 milliohm (±10%) resistive load.
- Recovery and start-up times are measured from application of the transient or change in condition to the point at which V_{OUT} is within 1% of final value.

- Step load test is performed at 10 microseconds typical.
- Step line test is performed at 100 microseconds ± 20 microseconds.
- Tested on release from inhibit.
- No effect on dc performance.

cMOR Single and Dual DC-DC Converters

15 TO 50 VOLT INPUT - UP TO 120 WATT

TABLE 7: ELECTRICAL CHARACTERISTICS -55 °C TO +105 °C CASE, 28 VIN, 100% LOAD, UNLESS OTHERWISE SPECIFIED

SINGLE OUTPUT MODELS		cMOR2828S			UNITS
PARAMETER	CONDITIONS	MIN	TYP	MAX	
OUTPUT VOLTAGE		27.30	28	28.70	V
OUTPUT CURRENT	$V_{IN} = 15 \text{ TO } 50 \text{ V}$			4.3	A
OUTPUT POWER	$V_{IN} = 15 \text{ TO } 50 \text{ V}$			120	W
OUTPUT RIPPLE	25 °C			300	mV p-p
10 kHz - 20 MHz	-55 °C TO +105 °C			300	
LINE REGULATION	$V_{IN} = 15 \text{ TO } 50 \text{ V}$			140	mV
LOAD REGULATION	NO LOAD TO FULL			280	mV
INPUT VOLTAGE	CONTINUOUS	15	28	50	V
INPUT CURRENT	NO LOAD			150	mA
	INHIBITED-INH1			12	
	INHIBITED-INH2			80	
INPUT RIPPLE CURRENT	10 kHz - 20 MHz			130	mA p-p
EFFICIENCY	25 °C	90	91		%
	-55 °C TO +105 °C	90			
LOAD FAULT ^{2, 3}	SHORT CIRCUIT			40	W
POWER DISSIPATION	RECOVERY ¹			10	ms
STEP LOAD RESPONSE ^{3, 4}	TRANSIENT			±1400	mV pk
50% - 100% - 50%	RECOVERY			300	µs
STEP LINE RESPONSE ^{1, 3, 5}	TRANSIENT			±1400	mV pk
$V_{IN} = 15 - 50 - 15 \text{ V}$	RECOVERY			300	µs
START-UP ^{3, 6}	DELAY			30	ms
	OVERSHOOT ¹			50	mV pk
CAPACITIVE LOAD ^{1, 7}	$T_C = 25 \text{ °C}$			875	µF

Notes

1. Guaranteed by characterization test and/or analysis. Not a production test.
2. Short circuit is measured with a 10 milliohm ($\pm 10\%$) resistive load.
3. Recovery and start-up times are measured from application of the transient or change in condition to the point at which V_{OUT} is within 1% of final value.

4. Step load test is performed at 10 microseconds typical.
5. Step line test is performed at 100 microseconds \pm 20 microseconds.
6. Tested on release from inhibit.
7. No effect on dc performance.

cMOR Single and Dual DC-DC Converters

15 TO 50 VOLT INPUT - UP TO 120 WATT

TABLE 8: ELECTRICAL CHARACTERISTICS -55 °C TO +105 °C CASE, 28 VIN, 100% LOAD, UNLESS OTHERWISE SPECIFIED

DUAL OUTPUT MODELS		cMOR283R3D			cMOR2805D			cMOR286R3D			UNITS
PARAMETER	CONDITIONS	MIN	TYP	MAX	MIN	TYP	MAX	MIN	TYP	MAX	
OUTPUT VOLTAGE ²	+V _{OUT}	3.20	3.30	3.38	4.88	5.00	5.13	6.17	6.30	6.43	V
	-V _{OUT}	-3.44	-3.42	-3.18	-5.18	-5.00	-4.82	-6.48	-6.30	-6.12	
OUTPUT CURRENT ³ V _{IN} = 15 TO 50 V	EITHER OUTPUT	—	±10	14	—	±10	14	—	±8	11.2	A
	TOTAL	—	—	20	—	—	20	—	—	16	
OUTPUT POWER ³ V _{IN} = 15 TO 50 V	EITHER OUTPUT	—	±33	46.2	—	±50	70	—	±50	70	W
	TOTAL	—	—	66	—	—	100	—	—	100	
OUTPUT RIPPLE ±V _{OUT} 10 KHZ - 20 MHZ	25 °C	—	—	70	—	—	75	—	—	90	mV p-p
	-55 °C TO +105 °C	—	50	80	—	50	80	—	50	100	
LINE REGULATION V _{IN} = 15 TO 50 V	+V _{OUT}	—	—	17	—	—	50	—	—	32	mV
	-V _{OUT}	—	—	33	—	—	100	—	—	63	
LOAD REGULATION	+V _{OUT}	—	—	33	—	—	50	—	—	63	mV
	-V _{OUT}	—	—	165	—	—	250	—	—	252	
CROSS REGULATION ^{1, 4}	-V _{OUT}	—	6	10	—	5	8	—	5	8	%
INPUT VOLTAGE	CONTINUOUS	15	28	50	15	28	50	15	28	50	V
		—	—	—	—	—	—	—	—	—	
INPUT CURRENT	NO LOAD	—	—	250	—	—	250	—	—	250	mA
	INHIBITED-INH1	—	—	10	—	—	10	—	—	10	
	INHIBITED-INH2	—	—	100	—	—	100	—	—	100	
INPUT RIPPLE CURRENT	10 KHZ - 20 MHZ	—	60	90	—	60	130	—	—	130	mA p-p
EFFICIENCY	25 °C	86	87	—	89	90	—	90	91	—	%
	-55 °C TO +105 °C	84	—	—	88	—	—	90	—	—	
LOAD FAULT ^{5, 6}	SHORT CIRCUIT	—	—	35	—	—	35	—	—	35	W
POWER DISSIPATION	RECOVERY ¹	—	—	30	—	—	30	—	—	30	ms
STEP LOAD RESPONSE ^{6, 7} ±V _{OUT} 50% - 100% - 50%	TRANSIENT	—	—	±TBD	—	—	±TBD	—	—	±TBD	mV pk
	RECOVERY	—	—	300	—	—	200	—	—	300	µs
STEP LINE RESPONSE ^{1, 6, 8} V _{IN} = 15 - 50 - 15 V	TRANSIENT	—	—	±430	—	—	±400	—	—	±500	mV pk
	RECOVERY	—	—	100	—	—	100	—	—	100	µs
START-UP ^{6, 9}	DELAY	—	—	30	—	—	30	—	—	30	ms
	OVERSHOOT ¹	—	—	25	—	—	50	—	—	50	mV pk
CAPACITIVE LOAD ^{1, 10}	T _C = 25 °C	—	—	1750	—	—	1750	—	—	1750	µF

Notes

1. Guaranteed by characterization test and/or analysis. Not a production test.
2. Output voltage for dual output models is measured with balanced loads.
3. The "Total" specification is the maximum combined current/power of both outputs. Up to 70% of that total is available from either output provided the other output maintains a minimum of 30% of the total power used. The 15% minimum maintains regulation.
4. Effect on negative V_{out} from 50%/50% loads to 70%/30% or 30%/70% loads.

5. Short circuit is measured with a 10 milliohm (±10%) resistive load. Both outputs shorted simultaneously.
6. Recovery and start-up times are measured from application of the transient or change in condition to the point at which V_{OUT} is within 1% of final value.
7. Step load test is performed at 10 microseconds typical.
8. Step line test is performed at 100 microseconds ± 20 microseconds.
9. Tested on release from inhibit.
10. Each output. No effect on dc performance.

cMOR Single and Dual DC-DC Converters

15 TO 50 VOLT INPUT - UP TO 120 WATT

TABLE 9: ELECTRICAL CHARACTERISTICS -55 °C TO +105 °C CASE, 28 VIN, 100% LOAD, UNLESS OTHERWISE SPECIFIED

DUAL OUTPUT MODELS		cMOR289R5D			cMOR2812D			cMOR2815D			UNITS
PARAMETER	CONDITIONS	MIN	TYP	MAX	MIN	TYP	MAX	MIN	TYP	MAX	
OUTPUT VOLTAGE ²	+V _{OUT}	9.40	9.50	9.60	11.75	12.00	12.24	14.70	15.00	15.30	V
	-V _{OUT}	-9.65	-9.50	9.35	-12.30	12	-11.70	-15.38	-15.00	-14.62	
OUTPUT CURRENT ³ V _{IN} = 15 TO 50 V	EITHER OUTPUT	—	±5.53	7.74	—	±4.58	6.41	—	±4	11.2	A
	TOTAL	—	—	11.05	—	—	9.16	—	—	16	
OUTPUT POWER ³ V _{IN} = 15 TO 50 V	EITHER OUTPUT	—	±52.5	73.5	—	±50	77	—	±60	70	W
	TOTAL	—	—	105	—	—	110	—	—	1	
OUTPUT RIPPLE ±V _{OUT} 10 KHZ - 20 MHZ	25 °C	—	—	100	—	—	75	—	—	90	mV p-p
	-55 °C TO +105 °C	—	75	120	—	75	120	—	75	120	
LINE REGULATION V _{IN} = 15 TO 50 V	+V _{OUT}	—	—	48	—	—	60	—	—	32	mV
	-V _{OUT}	—	—	95	—	—	120	—	—	63	
LOAD REGULATION	+V _{OUT}	—	—	95	—	—	120	—	—	63	mV
	-V _{OUT}	—	—	285	—	—	250	—	—	252	
CROSS REGULATION ^{1, 4}	-V _{OUT}	—	4	7	—	3	5	—	2	8	%
INPUT VOLTAGE	CONTINUOUS	15	28	50	15	28	50	15	28	50	V
		—	—	—	—	—	—	—	—	—	
INPUT CURRENT	NO LOAD	—	70	250	—	70	250	—	70	250	mA
	INHIBITED-INH1	—	—	10	—	—	10	—	—	10	
	INHIBITED-INH2	—	—	100	—	—	100	—	—	100	
INPUT RIPPLE CURRENT	10 KHZ - 20 MHZ	—	60	130	—	—	130	—	—	130	mA p-p
EFFICIENCY	25 °C	90	90	—	90	92	—	90	91	—	%
	-55 °C TO +105 °C	90	—	—	90	—	—	90	—	—	
LOAD FAULT ^{5, 6}	SHORT CIRCUIT	—	—	35	—	—	35	—	—	35	W
POWER DISSIPATION	RECOVERY ¹	—	—	30	—	—	30	—	—	30	ms
STEP LOAD RESPONSE ^{6, 7} ±V _{OUT} 50% - 100% - 50%	TRANSIENT	—	—	±TBD	—	—	±TBD	—	—	±600	mV pk
	RECOVERY	—	—	300	—	—	300	—	—	300	µs
STEP LINE RESPONSE ^{1, 6, 8} V _{IN} = 15 - 50 - 15 V	TRANSIENT	—	—	±570	—	—	±600	—	—	±600	mV pk
	RECOVERY	—	—	100	—	—	100	—	—	100	µs
START-UP ^{6, 9}	DELAY	—	—	30	—	—	30	—	—	30	ms
	OVERSHOOT ¹	—	—	25	—	—	25	—	—	50	mV pk
CAPACITIVE LOAD ^{1, 10}	T _C = 25 °C	—	—	1750	—	—	1750	—	—	1750	µF

Notes

- Guaranteed by characterization test and/or analysis. Not a production test.
- Output voltage for dual output models is measured with balanced loads.
- The "Total" specification is the maximum combined current/power of both outputs. Up to 70% of that total is available from either output provided the other output maintains a minimum of 30% of the total power used. The 15% minimum maintains regulation.
- Effect on negative V_{out} from 50%/50% loads to 70%/30% or 30%/70% loads.

- Short circuit is measured with a 10 milliohm (±10%) resistive load. Both outputs shorted simultaneously.
- Recovery and start-up times are measured from application of the transient or change in condition to the point at which V_{OUT} is within 1% of final value.
- Step load test is performed at 10 microseconds typical.
- Step line test is performed at 100 microseconds ± 20 microseconds.
- Tested on release from inhibit.
- Each output. No effect on dc performance.

cMOR Single and Dual DC-DC Converters

15 TO 50 VOLT INPUT - UP TO 120 WATT

TYPICAL PERFORMANCE PLOTS: 25 °C CASE, 28 VIN, 100% LOAD, UNLESS OTHERWISE SPECIFIED.
 THESE ARE EXAMPLES FOR REFERENCE ONLY AND ARE NOT GUARANTEED SPECIFICATIONS.

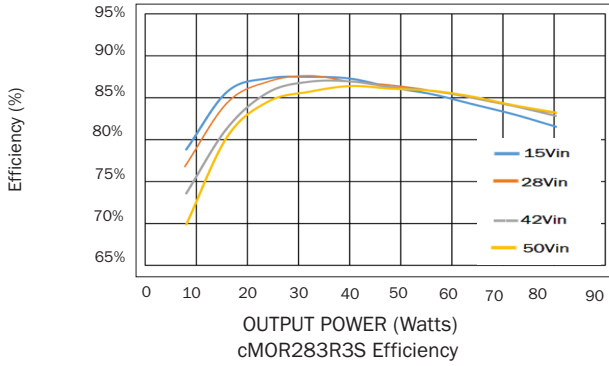

FIGURE 12

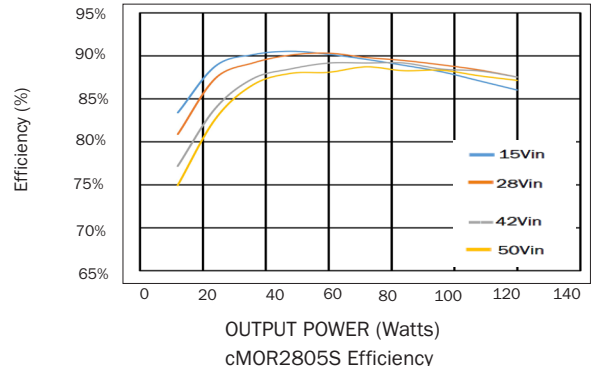

FIGURE 13

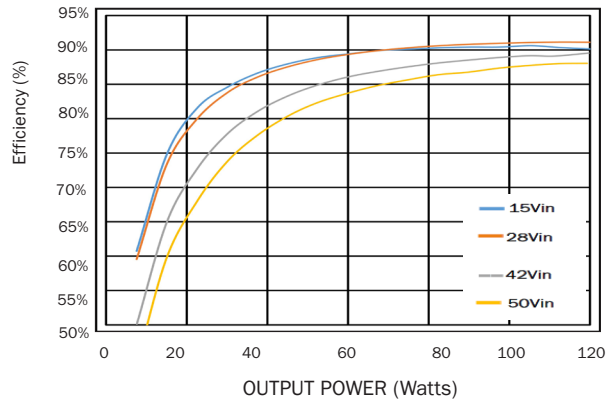

FIGURE 14

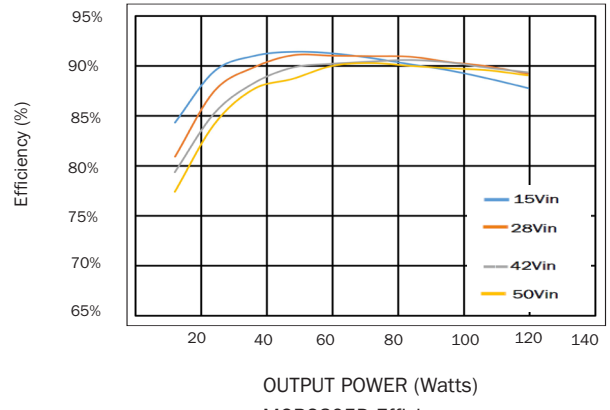

FIGURE 15

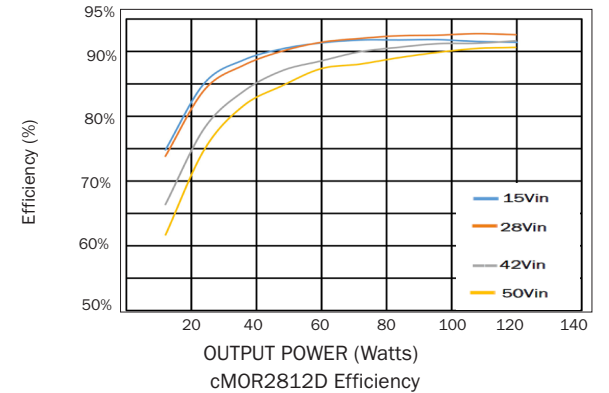

FIGURE 16

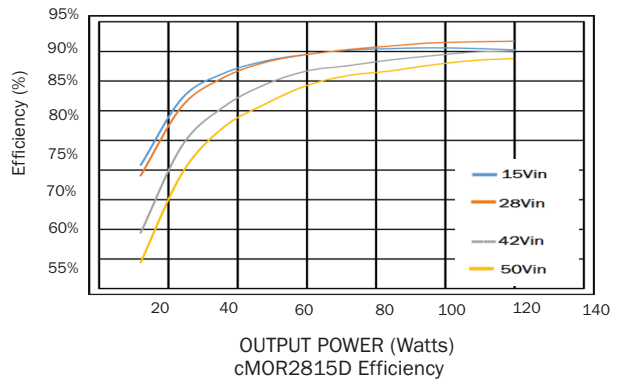
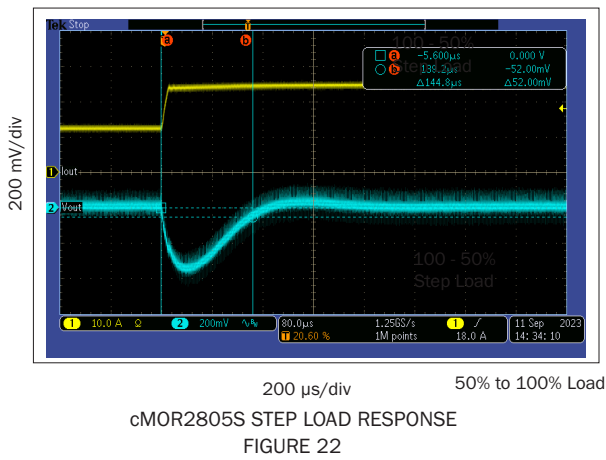
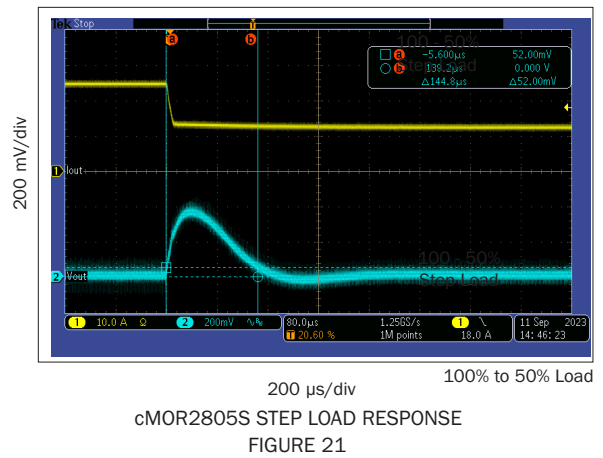
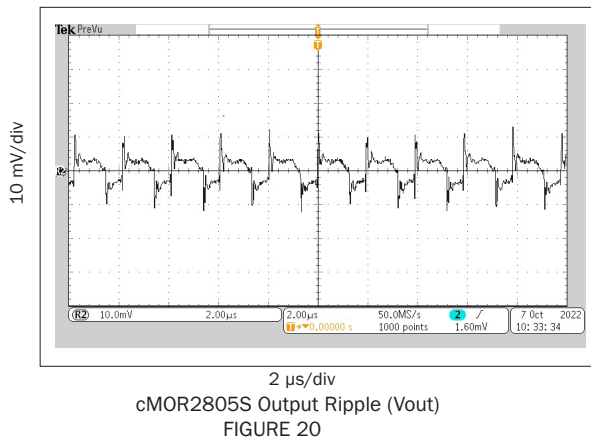
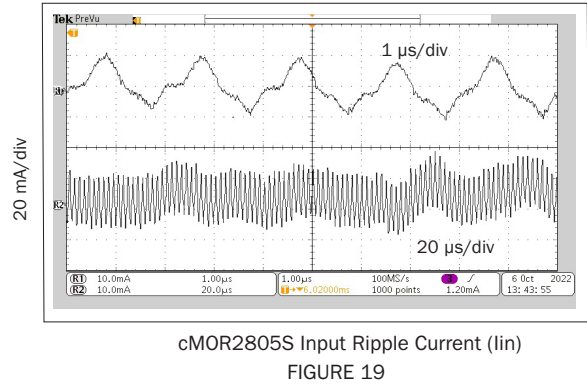
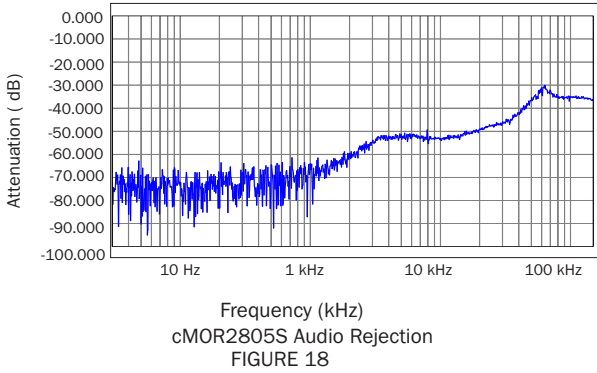

FIGURE 17

cMOR Single and Dual DC-DC Converters

15 TO 50 VOLT INPUT - UP TO 120 WATT

TYPICAL PERFORMANCE PLOTS: 25 °C CASE, 28 VIN, 100% LOAD, UNLESS OTHERWISE SPECIFIED.
 THESE ARE EXAMPLES FOR REFERENCE ONLY AND ARE NOT GUARANTEED SPECIFICATIONS.



cMOR Single and Dual DC-DC Converters

15 TO 50 VOLT INPUT - UP TO 120 WATT

TYPICAL PERFORMANCE PLOTS: 25 °C CASE, 28 VIN, 100% LOAD, UNLESS OTHERWISE SPECIFIED.
 THESE ARE EXAMPLES FOR REFERENCE ONLY AND ARE NOT GUARANTEED SPECIFICATIONS.

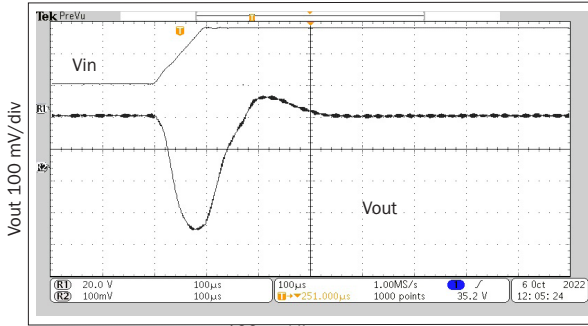

100 μs/div
 15 to 50 V
cMOR2805S STEP LINE RESPONSE

FIGURE 23

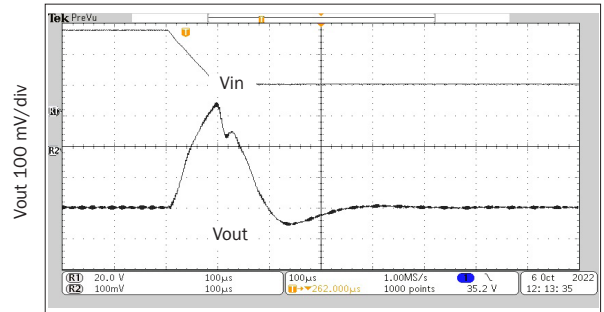

100 μs/div
 50 to 15 V
cMOR2805S STEP LINE RESPONSE

FIGURE 24

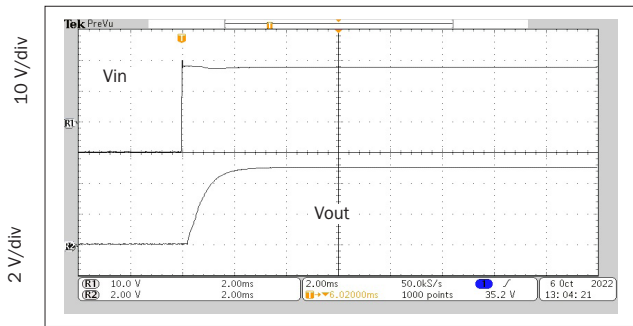

2 ms/div
 All combinations of line and load
cMOR2805S START-UP RESPONSE

FIGURE 25

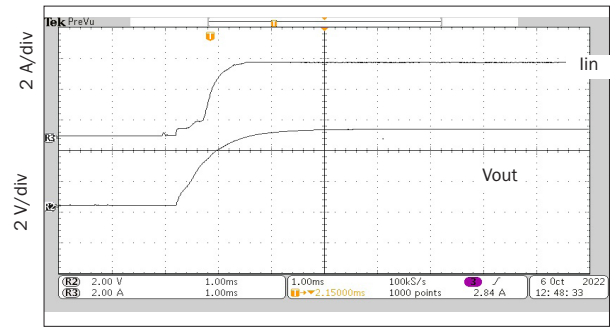

1 ms/div
cMOR2805S INHIBIT RELEASE INRUSH CURRENT

FIGURE 26

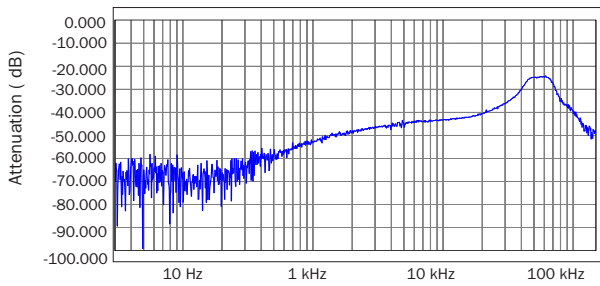

Frequency (kHz)
cMOR2815D Audio Rejection

FIGURE 27

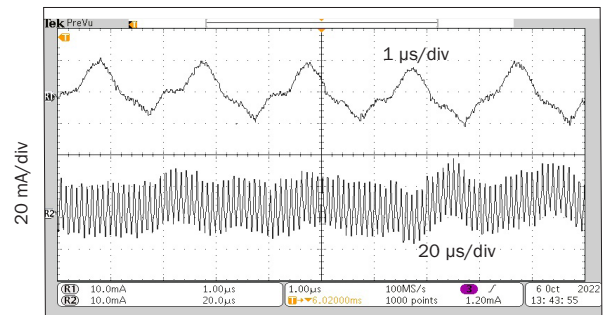

(PLACE HOLDER_PENDING) rMOR2815D Input Ripple Current (lin)
FIGURE 28

cMOR Single and Dual DC-DC Converters

15 TO 50 VOLT INPUT - UP TO 120 WATT

TOP VIEW CASE U2
Flanged case, short leads

Case "U2" does not require a designator in the Case Option position of the model number for the cMOR family

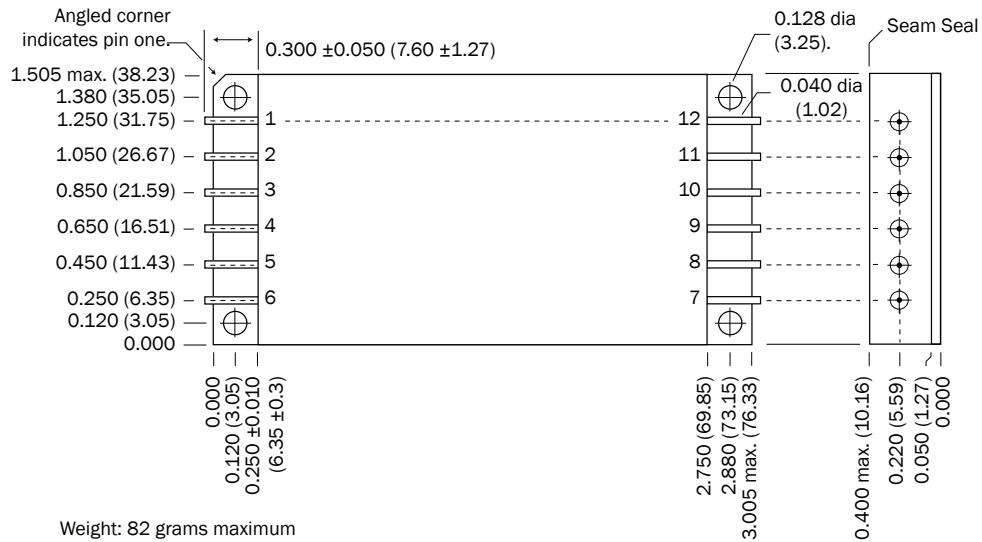

Weight: 82 grams maximum

Case dimensions in inches (mm)
Tolerance ±0.005 (0.13) for three decimal places
±0.01 (0.3) for two decimal places
unless otherwise specified

CAUTION

Heat from reflow or wave soldering may damage the device. Solder pins individually with heat application not exceeding 300°C for 10 seconds per pin.

Materials

- Header Cold Rolled Steel/Nickel
- Nickel plating of 200 microinches MIN
- Cover Kovar/Nickel
- Pins Alloy 52/Copper, compression glass seal
- Gold plating of 50 microinches MIN over
- Nickel plating of 200 microinches MIN
- Seal Hole: 0.098 ±0.002 (2.49 ±0.05)

Please refer to the numerical dimensions for accuracy.

Figure 29: Case U2

cMOR Single and Dual DC-DC Converters

15 TO 50 VOLT INPUT - UP TO 120 WATT

TOP VIEW CASE V
Flanged case, down leaded

Case "V" requires a "V" in the Case Option position of the model number.

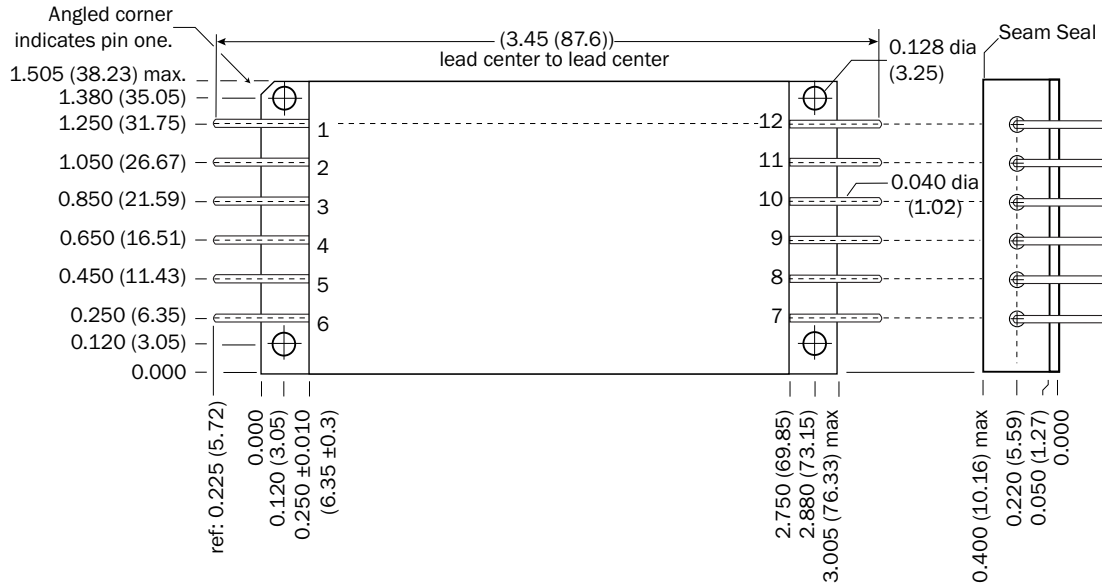

Weight: 84 grams maximum

Case dimensions in inches (mm)
Tolerance ± 0.005 (0.13) for three decimal places
 ± 0.01 (0.3) for two decimal places
unless otherwise specified

CAUTION
Heat from reflow or wave soldering may damage the device. Solder pins individually with heat application not exceeding 300°C for 10 seconds per pin.

Materials
Header Cold Rolled Steel/Nickel
Nickel plating of 200 microinches MIN
Cover Kovar/Nickel
Pins Alloy 52/Copper, compression glass seal
Gold plating of 50 microinches MIN over
Nickel plating of 200 microinches MIN
Seal Hole: 0.098 ± 0.002 (2.49 \pm 0.05)

Please refer to the numerical dimensions for accuracy.

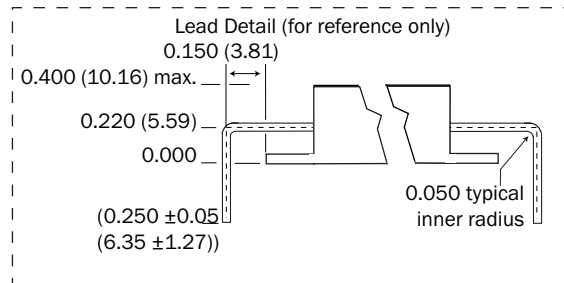

FIGURE 30: CASE V

cMOR Single and Dual DC-DC Converters

15 TO 50 VOLT INPUT - UP TO 120 WATT

TOP VIEW CASE W
Tabbed case, up-leaded

Case "W" requires a "W" in the Case Option position of the model number.

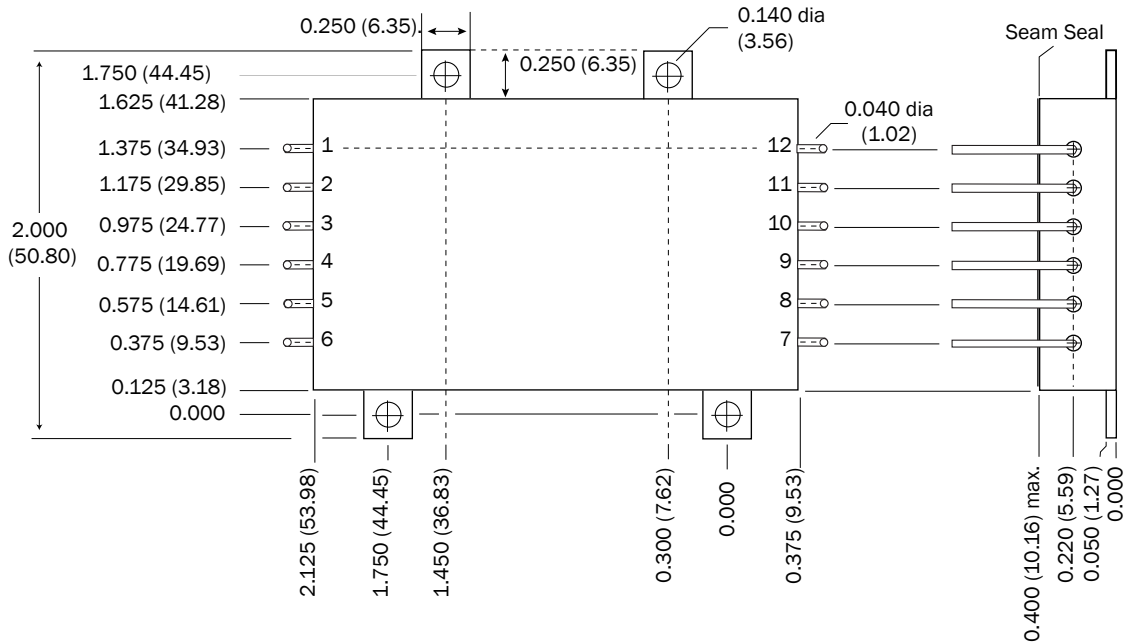

Weight: 79 grams maximum

Case dimensions in inches (mm)
Tolerance ± 0.005 (0.13) for three decimal places
 ± 0.01 (0.3) for two decimal places
unless otherwise specified

CAUTION
Heat from reflow or wave soldering may damage the device. Solder pins individually with heat application not exceeding 300°C for 10 seconds per pin.

Materials
Header Cold Rolled Steel/Nickel
Nickel plating of 200 microinches MIN
Cover Kovar/Nickel
Pins Alloy 52/Copper, compression glass seal
Gold plating of 50 microinches MIN over
Nickel plating of 200 microinches MIN
Seal Hole: 0.098 ± 0.002 (2.49 \pm 0.05)

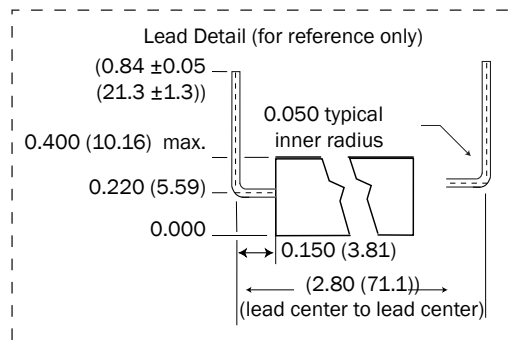

Please refer to the numerical dimensions for accuracy.

FIGURE 31: CASE W

cMOR Single and Dual DC-DC Converters

15 TO 50 VOLT INPUT - UP TO 120 WATT

TOP VIEW CASE Y
Tabbed case, straight-leaded

Case "Y" requires a "Y" in the Case Option position of the model number.

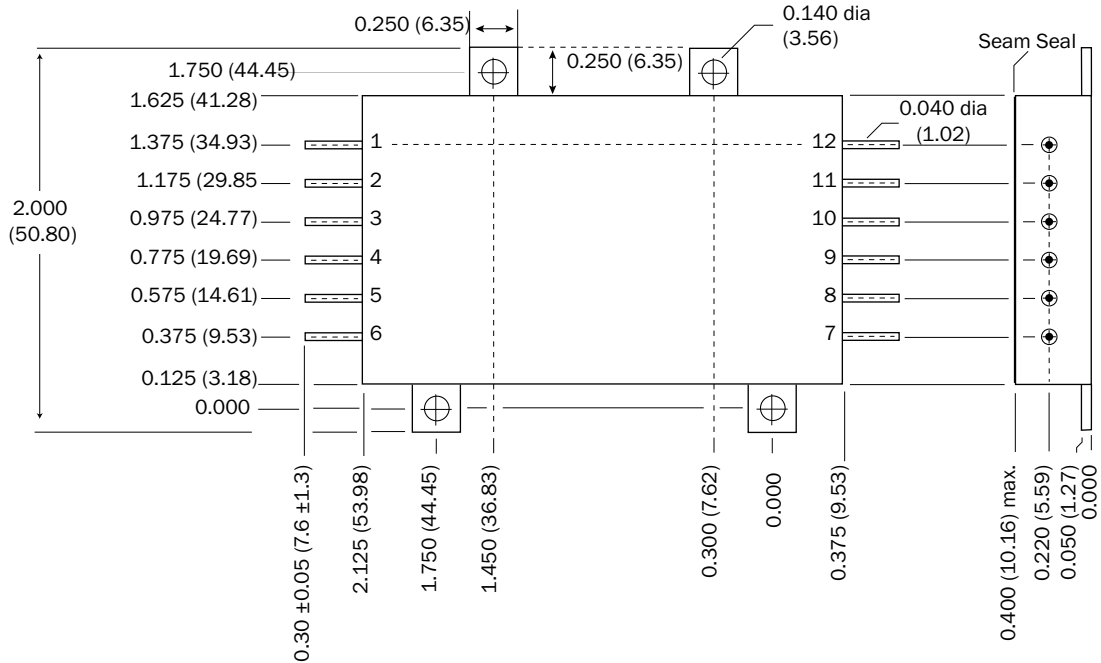

Weight: 79 grams maximum

Case dimensions in inches (mm)
Tolerance ± 0.005 (0.13) for three decimal places
 ± 0.01 (0.3) for two decimal places
unless otherwise specified

CAUTION
Heat from reflow or wave soldering may damage the device. Solder pins individually with heat application not exceeding 300°C for 10 seconds per pin.

Materials
Header Cold Rolled Steel/Nickel/
Nickel plating of 200 microinches MIN
Cover Kovar/Nickel
Pins Alloy 52/Copper, compression glass seal
Gold plating of 50 microinches MIN over
Nickel plating of 200 microinches MIN
Seal Hole: 0.98 ± 0.002 (2.49 \pm 0.05)

Please refer to the numerical dimensions for accuracy.

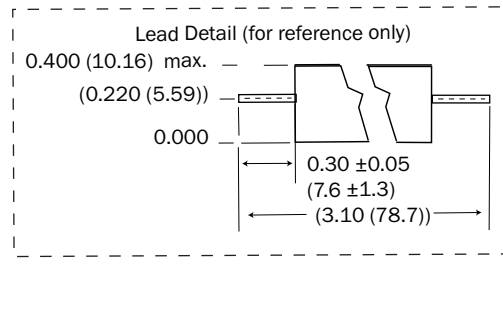

FIGURE 32: CASE Y

cMOR Single and Dual DC-DC Converters

15 TO 50 VOLT INPUT - UP TO 120 WATT

TOP VIEW CASE Z
Tabbed case, down-leaded

Case "Z" requires a "Z" in the Case Option position of the model number.

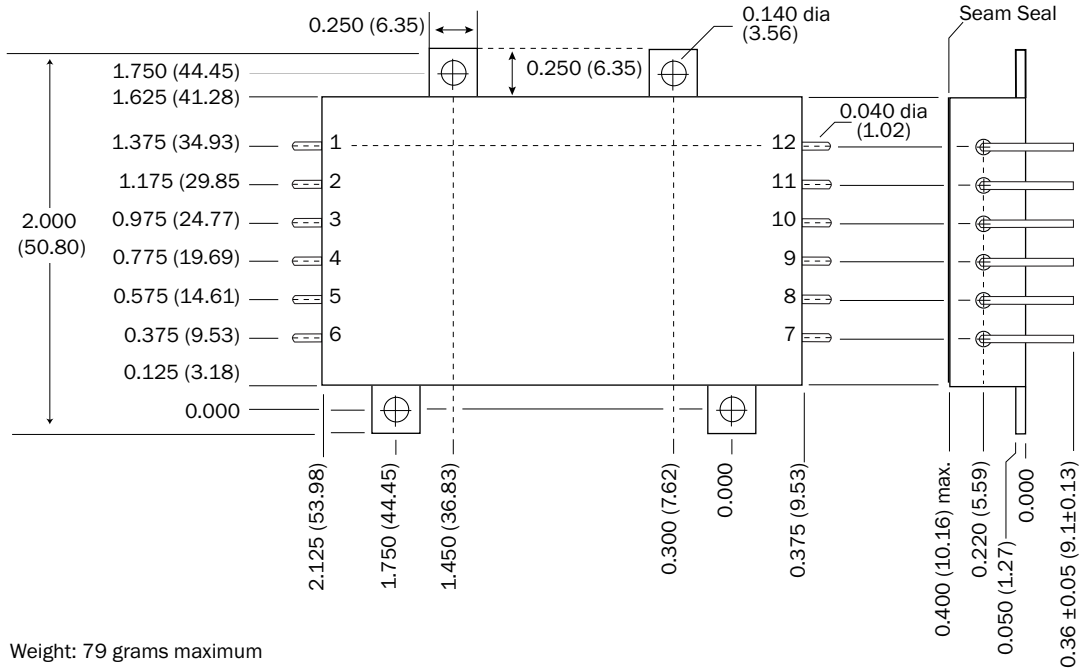

Weight: 79 grams maximum

Case dimensions in inches (mm)
Tolerance ±0.005 (0.13) for three decimal places
±0.01 (0.3) for two decimal places
unless otherwise specified

CAUTION
Heat from reflow or wave soldering may damage the device.
Solder pins individually with heat application not exceeding 300 °C for 10 seconds per pin.

- Materials**
- Header: Cold Rolled Steel/Nickel
Nickel plating of 200 microinches MIN
 - Cover: Kovar/Nickel
 - Pins: Alloy 52/Copper, compression glass seal
Gold plating of 50 microinches MIN over
Nickel plating of 200 microinches MIN
Seal Hole: 0.098 ± 0.002 (2.49 ± 0.05)

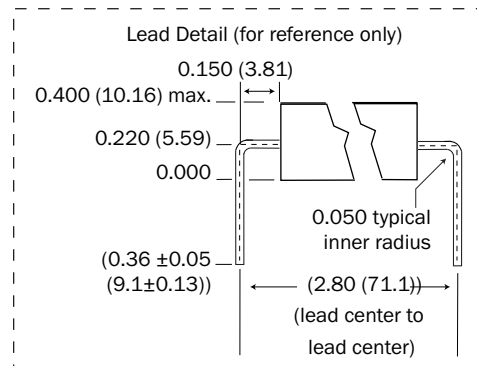

Please refer to the numerical dimensions for accuracy.

FIGURE 33: CASE Z

cMOR Single and Dual DC-DC Converters

15 TO 50 VOLT INPUT - UP TO 120 WATT

CMOR PRODUCT QUALIFICATION REQUIREMENTS				
Subgroup	Test	883 Test Method	Conditions	QTY (Accept Number)
1	Resistance to Soldering Heat	2036		5(0)
	External Visual	2009		
	Temperature Cycling	1010	B, 20 cycles	
	Mechanical Shock	2002	A, Y1 direction	
	Constant Acceleration	2001	500g	
	Random Vibration	2026	F	
	Seal (Gross Leak, Dip)	1014		
	End-point-Electrical	Per ATP		
2	Steady-state life test	1005	1000 hours at +105C	22(0)
	End-point Electrical	Per ATP		
4	Internal Visual	IPC-A-610 Class 3		5(0)
5	ESD	3015		3(0)
	End-point Electrical	Per ATP		

TABLE 10: PRODUCT QUALIFICATION REQUIREMENTS

cMOR Single and Dual DC-DC Converters

15 TO 50 VOLT INPUT - UP TO 120 WATT

ENVIRONMENTAL SCREENING COTS, STANDARD AND /ES

TEST PERFORMED	STANDARD	/ES
Pre-cap Inspection, IPC - 610 Class-3	■	■
Temperature Cycle (10 times) MIL-STD-883, Method 1010, Cond. B, -55 °C to +105 °C, ambient		■
Constant Acceleration Method 2001, 300 g		■
Burn-in Method 1015, +105 °C case, typical 24 hours	■	
96 hours		■
Final Electrical Test -55 °C, +25 °C, +105 °C case	■	■
Hermeticity Test, Method 1014 Gross Leak, Cond. C ₁ , fluorocarbon		■
Gross Leak, Dip	■	
Final visual inspection, Method 2009	■	■

Test methods are referenced to MIL-STD-883 as determined by MIL-PRF-38534.

Notes

1. Standard and /ES products may not meet all of the requirements of MIL-PRF-38534.
2. Burn-in temperature designed to bring the case temperature to the maximum case temperature of the product. Refer to the specific product information for the maximum case temperature. Burn-in is a powered test.

TABLE 11: ENVIRONMENTAL SCREENING HIGH RELIABILITY COTS DC-DC CONVERTERS COTS, STANDARD AND /ES

